



INSTALLATION, OPERATION, & MAINTENANCE MANUAL



ICP-110
ICP-110S
ICP-40DC
ICP-40DCS
ICP-24ACS
ICP-100 Plus
ICP-120 Plus
ICP-301 Plus
ICP-401 Plus
ICP-CRA-100
ICP-CRA-120
ICP-CRA-160DC

CONTENTS

- Installation Instructions
- Dimensional Drawings
- Wiring Diagrams
- Operation and Maintenance



INSTALLATION **INSTRUCTIONS**

ICP-110, ICP-110S, ICP-40DC, ICP-40DCS, ICP-24ACS

- Disconnect power before installing.
- Mount 8 terminal base as close as possible to the power source to minimize conductor length (no longer than 18 inches).
- Wire base in accordance with wiring diagram on page 5.
- Plug ICP into octal socket.
- Re-energize.



INSTALLATION **INSTRUCTIONS**

ICP-120 Plus, ICP-301 Plus, ICP-401 Plus, ICP-100 Plus

- Disconnect power before installing.
- Mount the ICP Plus mounting bracket as close as possible to connection points. Secure mounting bracket with appropriate screws or fasteners for the material holding the bracket.
- Secure the ICP Plus into the bracket.
- Cut conductors as short as possible without straining or creating sharp bends.
- Strip $\frac{1}{4}$ inch off each conductor and insert into the appropriate terminals according to the wiring diagram on page 6. Tighten each terminal screw.

Note: Do not connect Neutral conductor to Ground.

COMMUNICATION/ALARM HOOKUP

Note: This is any system interconnection interlock from 5 to 240 VAC or VDC. This alarm connection is an isolated, normally closed or normally open contact. It may be used to stop a process when the ICP Plus has been expended or when voltage drops below 75% of nominal voltage.

- Connect the C terminal conductor to power source of system control interface.
- Connect the NO or NC conductor to the input of the system control interface.



INSTALLATION **INSTRUCTIONS**

ICP-CRA-160DC, ICP-CRA-120, ICP-CRA-100

- Disconnect power before installing.
- Mount the ICP-CRA enclosure as close as possible to the connection points. Remove the 4 cover screws to access the mounting holes on the back of the enclosure.
- Insert conductors through the panel opening and tighten the locknut.
- Cut conductors as short as possible without straining or creating sharp bends to connect.
- Connect conductors according to wiring diagram on page 7.
- Insert the ICP(s) into the 8-pin base(s).
- Re-energize.

ALARM HOOKUP

Note: This is any system interconnection interlock from 5V to 240V (AC or DC). This alarm connection is an isolated, normally closed or normally open contact. It may be used to stop a process when an ICP has been expended or when voltage drops below 75% of nominal voltage.

- Connect the Common conductor to the power source of system control interface.
- Connect the Normally Closed or Normally Open conductor to the input of the system control interface. The alarm interface may alternatively be connected to an audible or visual indicator.



DIMENSIONAL DRAWINGS

ICP-100
ICP-110S
ICP-40DC
ICP-40DCS
ICP-24ACS

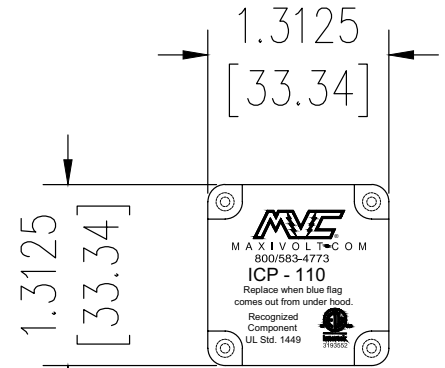
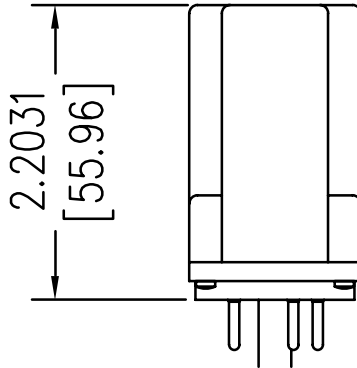

ICP-100 PLUS
ICP-120 PLUS
ICP-301 PLUS
ICP-401 PLUS

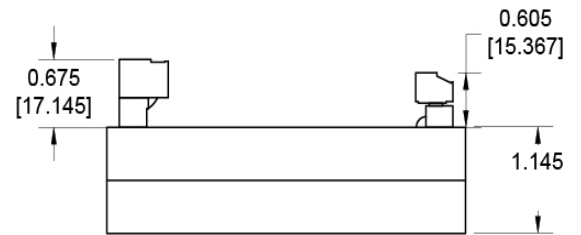
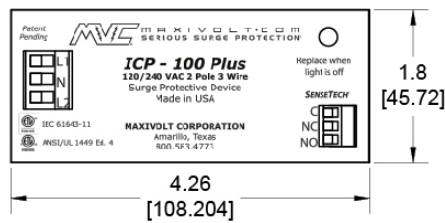

ICP-CRA-160DC
ICP-CRA-120
ICP-CRA-100

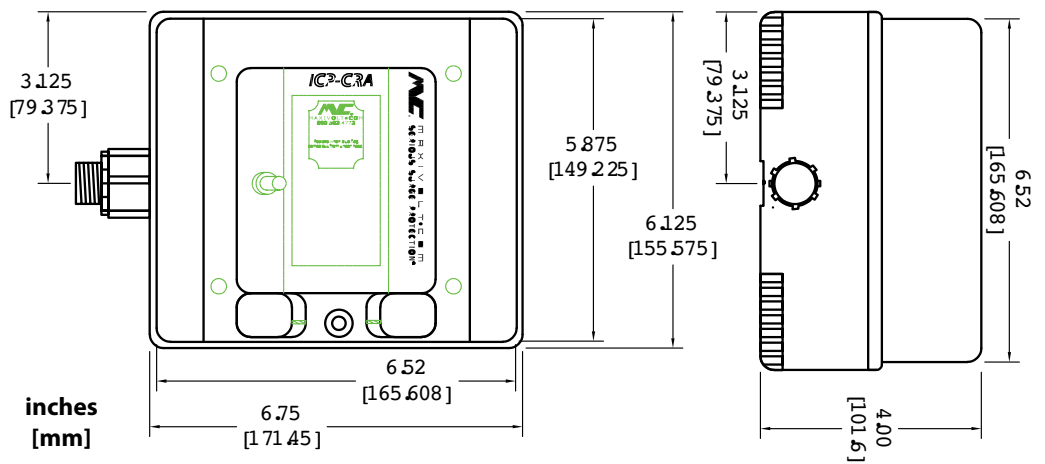



WIRING **DIAGRAMS**

ICP-110

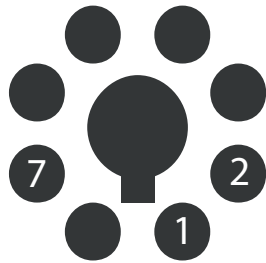

Terminal 7 to Phase
Terminal 2 to Neutral
Terminal 1 to Alarm

ICP-40DC

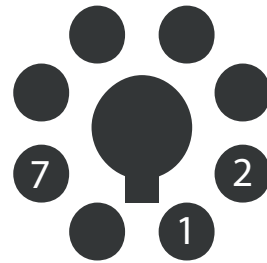

Terminal 7 to "+"
Terminal 2 to "-"
Terminal 1 to Alarm

ICP-110S

ICP-24ACS

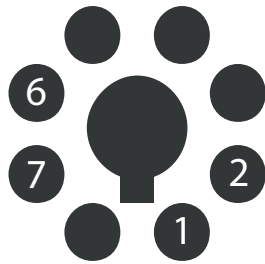

Terminal 7 to Phase
Terminal 2 to Neutral
Terminal 1 to Alarm
Terminal 6 to Load

ICP-40DCS

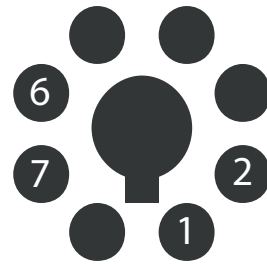

Terminal 7 to "+"
Terminal 2 to "-"
Terminal 1 to Alarm
Terminal 6 to Load



WIRING DIAGRAMS

ICP-120 Plus

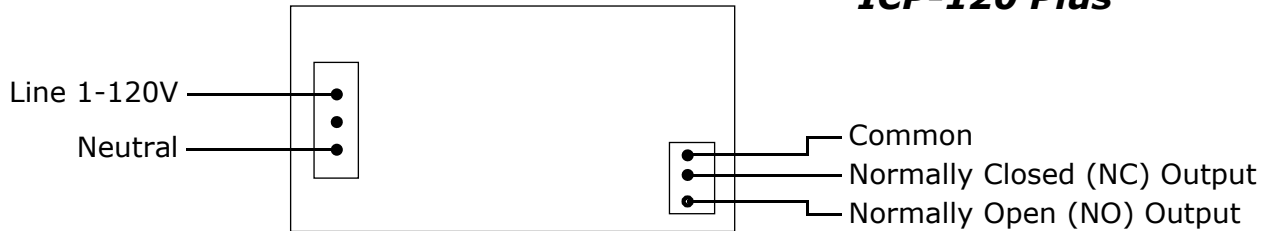

ICP-301 Plus

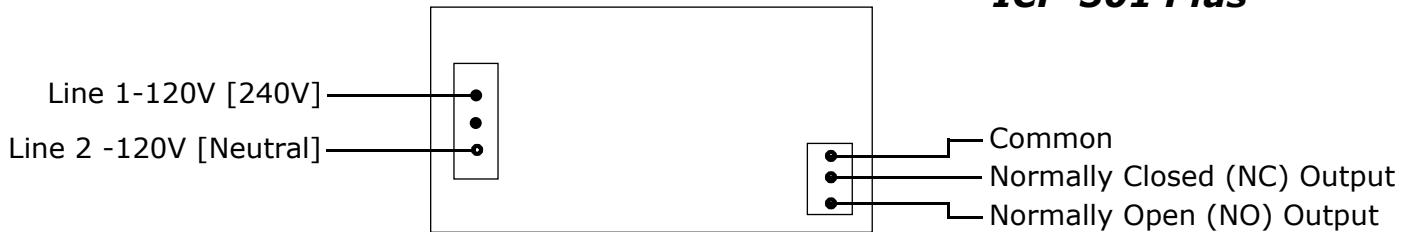

ICP-401 Plus

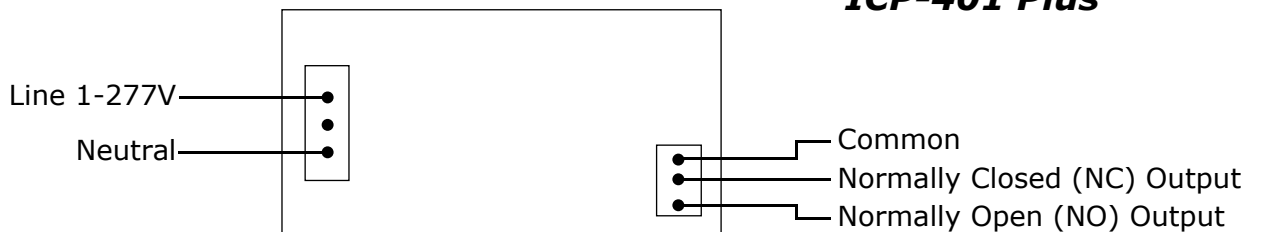

ICP-100 Plus

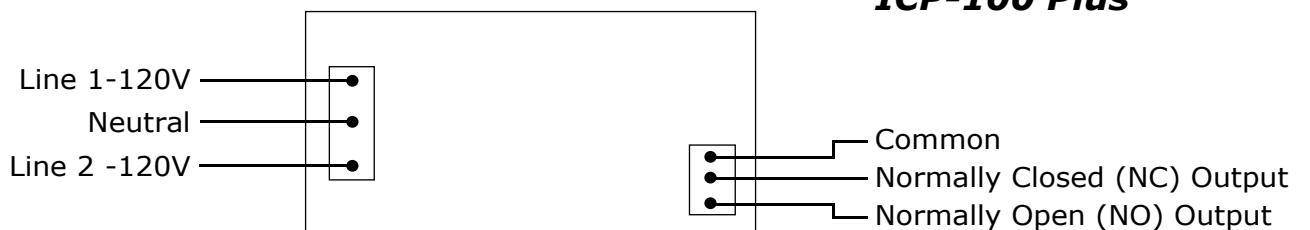



WIRING DIAGRAMS

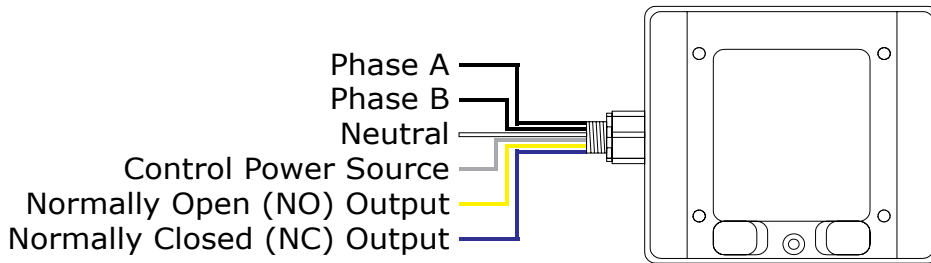

ICP-CRA-100

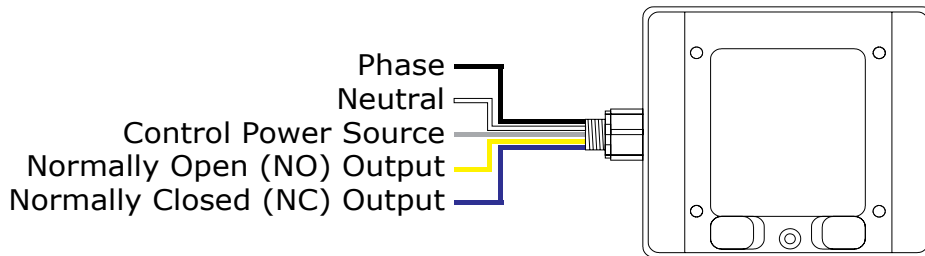

ICP-CRA-120

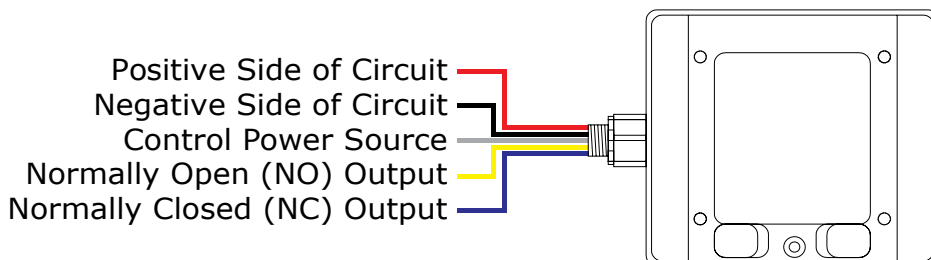

ICP-CRA-160C



OPERATION AND **MAINTENANCE**

Add the following to your routine inspection forms:

This device contains no field serviceable parts.

VISUAL INSPECTION

ICP Models

Blue flag is normally under fuse head. If blue flag is visible from above, SPD is expended and needs to be replaced.

ICP Plus Models

During normal operation, the green indicator LED will be on. If the green LED is off, check that proper voltage is being applied. If proper voltage is applied and the LED is off, the ICP Plus is expended and must be replaced.

ICP CRA Models

During normal operation, the red indicator light will be off. If the red light is on, check the fuse indicator on the ICPs. The ICP has expended when blue flag appears from under the hood when looking at the unit from the top. If the fuse indicator is visible, the ICP must be replaced. The Normally Open contact will not energize if either one or both ICPs have been expended.



ABOUT

Established in 1988, Maxivolt is a pioneer in the power quality industry with over a century of combined experience. Maxivolt manufactures specialized technology and provides value-added services custom-tailored to extend the life and protect the operational integrity of electrical and electronic equipment. Averted equipment failures and misoperations result in numerous long-term financial and operational benefits.

For more information, contact Maxivolt:

800-583-4773

info@maxivolt.com

